

2022 HS4 List Price Book

version 5.04



powered by **SALTO**

TABLE OF CONTENTS

TRAINING

Hager Authorized Salto Partner (HASP) Training	4
--	---

MOBILE APPS

Mobile App	4
BLE Module & Service Fees	4, 57

STARTER KIT

SVN Starter Kit	5-6
-----------------	-----

LOCKING DEVICES

HS4 Wide Body	7-9
HS4 Mini	10-11
HS4 AElement	12-15
HS4 AElement Fusion	16-17
HS4 Locker Lock	45
HS4 Exit Device Trim	46-47
HS4 Storefront Lock	48-49
HS4 Glass Door Locks	50-51

GEO CYLINDERS

HS4 Mortise	19-20
HS4 Rim	21-22
HS4 Deadbolt (Single Cylinder)	23
HS4 Deadbolt (Double Cylinder)	24-26
HS4 GEO with 3710 Interconnected	26-27
HS4 GEO and Conversion Kit (for 3710 or 3215)	28
HS4 Padlock	29-30
HS4 Cam Lock	31-32
HS4 GEO Grips	44
HS4 GEO Installation Tools	44

NEO CYLINDERS

HS4 Mortise	33-34
HS4 Rim	35-36
HS4 Deadbolt (Single Cylinder)	37
HS4 Deadbolt (Double Cylinder)	38-39
HS4 NEO Cam Lock	42-43
HS4 NEO Installation Tools	44

CARD READERS & CONTROL UNITS

HS4 Wall Readers	52
HS4 Control Units	52-53
HS4 Long Range Readers	53
HS4 RFnet & BLUenet Gateways & Nodes	54

MANAGEMENT TOOLS

HS4 Portable Programming Device	55
HS4 Card Encoder (NCoder)	55

continued on next page

SOFTWARE & CREDENTIALS

ProAccess Space Software	56-57
HS4 Smart Credentials	58-59
BLE Module & Service Fees	57

DEMO BLOCKS

Demo Blocks & Marketing Skins	60
-------------------------------	----

POWER SUPPLIES

29T Series	61-63
------------	-------

SYSTEM DESIGN

Compatibility Chart	64
---------------------	----

This is the 2022 list price book for HS4, the Hager powered by Salto access control locking platform.

HS4 HASP Annual Requirements

It is mandatory and without exception that any Hager customer intending to sell and or install the HS4 must first successfully complete the Hager Authorized Salto Partner (HASP) training program.

Refer to Hager the Hager price book for Terms and Conditions

Minimum Annual Purchase Requirement - HASP Distributors are required to complete a \$50,000 minimum annual purchase requirement in order to maintain HASP status.

Hager Authorized Salto Partner

Any customer intending to sell and/or install the HS4 platform must be authorized

Training				
HASP Authorization	HASPSTART	\$4,120.00	NET	1
<i>includes HASP training and start up</i>				
onsite	HASP	\$3,090.00	NET	1
<i>\$3,000 is the net price and does not include additional daily travel expenses</i>				

All HASP distributors will be required to reach a \$50,000 annual minimum beginning in 2019.

Salto JustIN Mobile App

BLE enabled devices can be operated with a BLE enabled smart device by using Salto's JustIN Mobile App that allows users to use their smartphone as their credential on SVN and RFnet locks

App			
Android		no charge	
iOS		no charge	
BLE Service Fees			
License Fee	SPACE-OPT-0028-2	\$879.52	LIST
<i>annual fee per project starting at the beginning of year 2</i>			
User Fee	SPACE-OPT-0016-1	\$5.92	LIST
<i>annual fee per registered phone number starting at the beginning of year 2</i>			

SVN Starter Kit

The HS4 Starter Kit includes all necessary components for a two reader SVN system.

Starter Kits are intended for system users to try the system with minimal investment. As an incentive to system users, Hager is offers a list price discount on Starter Kits.

SPABASxxxx includes:

(2) Wall Readers (select style and color)
Control Unit (with gray housing)
Portable Programming Device
BLE (USB & Ethernet) NCoder
ProAccess SPACE Basic Software
Credentials (pack of 50)

Individual Item List Price:

	\$684.60
	\$1,945.10
	\$1,103.97
	\$1,190.91
	\$896.71
	\$554.91
Individual Item Total	\$6,376.20
Starter Kit List Price	\$4,480.77
Starter Kit List Savings	\$1,895.43

SPAONLxxxx includes:

(2) Wall Readers (select style and color)
Control Unit (with gray housing)
Portable Programming Device
BLE (USB & Ethernet) NCoder
ProAccess SPACE Online Software
Credentials (pack of 50)

Individual Item List Price:

	\$684.60
	\$1,945.10
	\$1,103.97
	\$1,190.91
	\$1,673.71
	\$554.91
Individual Item Total	\$7,153.20
Starter Kit List Price	\$4,933.77
Starter Kit List Savings	\$2,219.43

Starter Kit Ordering Notes

Starter kits will not be allowed as a value engineering solution for project quotes.

Limit 1 starter kit to each purchase order

Please note that if the customer needs a software add-on, it must be ordered separately from the starter kit. Add-ons cannot be ordered until the starter kit ships.

continued on next page

Platform	Version	Reader #1	Reader #1 Color	Reader #1	Reader #1 Color	Remaining
SPA ProAccess SPACE	BAS SPABASIC0	A ANSI BLE (no keypad) WRDB0A4W0 WRDB0A4B0	W White	A ANSI BLE (no keypad) WRDB0A4W0 WRDB0A4B0	W White	BLE Encoder (USB & Ethernet) ECB04B0US Mifare Smart Credentials 4k, Hager powered by Salto (50 pack)
	ONL SPAONLINE	M Mullion BLE WRDB0M4W0 WRDB0M4B0	B Black	M Mullion BLE WRDB0M4W0 WRDB0M4B0	B Black	PPD Control Unit

Description	Part No.	2022 List	Stock No.	Box Qty.
Software				
ProAccess SPACE - Basic	SPABAS	\$4,480.77		
ProAccess SPACE - Online	SPAONL	\$4,933.77		
Reader #1 Type				
ANSI Proximity BLE Mifare/DESfire Wall Reader	A	-		
Mullion Proximity BLE Mifare/DESfire Wall Reader	M	-		
Reader #1 Color				
White	W	-		
Black	B	-		
Reader #2 Type				
ANSI Proximity BLE Mifare/DESfire Wall Reader	A	-		
Mullion Proximity BLE Mifare/DESfire Wall Reader	M	-		
Reader #2 Color				
White	W	-		
Black	B	-		
Encoder				
USB & Ethernet connection to PC	-	-		
Credentials				
Mifare Hager powered by Salto - 4k	-	-		50
Portable Programming Device				
USB connection to PC	-	-		
Control Unit				
CU42E0US0	-	-		

HS4 Wide Body

The HS4 Wide Body escutcheon is a robust, hardened steel escutcheon that can be used on any HS4 installation

How to Order Guide

HS4	Function	Lock Type	Platform	Finish	Reader Technology	Reader Color	Lever	Backset	Door Thickness	Strike	Key Override					
H HS4 Access Control	B Passage	38 Mortise Lock	A SVN	300 US3 Polished Brass (PVD)	9 Mifare DESfire (keypad only offered with BLE)	B Black	A Archer	2 2-3/4" (standard)	3 1-3/4" (standard)	A ASA Strike	- No Key Override (leave blank)					
			B RFnet Capable	400 US4 Satin Brass (PVD)						M Standard Strike						
			C RFnet							B 1-1/2" Ext. Lip Strike						
			D SVN AMOK	32D US32D Satin Stainless Steel						C 1-1/2" Round Corner Ext. Lip Strike						
			E SVN w/ keypad							D No Lip Strike						
			F RFnet Capable w/ keypad	320 US32 Bright Stainless Steel						E 7/8" Flat Lip Strike						
	E Entrance	34 Cylindrical Lock	G RFnet w/ keypad	BLK Black	B Mifare DESfire +BLE	W White	L William	G 2-3/8" cylindrical only	7 3" - 3-1/2"	F 1-3/16" Flat Lip Strike	000X Key Override No Core					
			H Thumbturn Privacy w/ Deadbolt (mortise only)	M SAN/SVN + BLUENet HSE						BIO BioCote		R 1-3/16" Round Corner Flat Lip Strike	000K Key Override w/ Cover			
			P Push Button Privacy													
			T Thumbturn Privacy w/ Deadbolt (mortise only)													

Description

Ordering Codes

2022 List

Stock No. Box Qty.

Lock Functions:

Grade 1 Cylindrical Lock Functions:

Passage Function	HB34	\$594.66	1
Storeroom Function (entrance)	HE34	\$1,382.02	1
Privacy Function	HP34	\$1,383.16	1
Grade 1 Mortise Lock Functions:			
Passage Function	HB38	\$615.64	1
3810 Mortise			
Storeroom Function (entrance)	HE38	\$1,398.36	1
3880 Mortise			
Push Button Privacy	HP38	\$1,384.35	1
3880 Mortise			
Thumbturn Privacy	HT38	\$1,406.52	1
3881 Mortise			

continued on next page

Platform:

w/o Keypad

SVN	A	standard
SVN + BLUEnet	M	\$6.18
SVN w/ AMOK	D	\$221.62

w/ Keypad (all keypad locks are Bluetooth enabled)

SVN	E	\$575.38
SVN + RFnet Capable	F	\$714.94
SVN + RFnet Ready (DPS required - see "Optional Features")	G	\$1,035.07

Finishes:

US32D - Satin Stainless Steel	32D	-
US32 - Bright Stainless Steel	320	\$28.58
US3 - Bright Brass (PVD)	300	\$28.92
US4 - Satin Brass (PVD)	400	-
BLK - Satin Chrome Black (William and Withnell levers)	BLK	\$60.74
BIO - Satin Stainless Steel BioCote	BIO	\$91.13



Reader Technology:

Mifare/DESfire	9	standard
<i>optional on RFnet keypad locks only</i>		
Mifare/DESfire + BLE	B	\$60.74

Reader Color:

Black	B	standard
White	W	

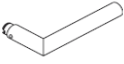
Lever Styles:

Archer	Available in US32D, US4, Black and BioCote (US32D)	A	-	2
				
Joshua	Available in US32D, US32, US3, US4, Black and BioCote (US32D)	D	-	2
				
William	Available in US32D, US32, US3, US4, Black and BioCote (US32D)	L	-	2
				
Withnell	Available in US32D, US32, US3, US4, Black and BioCote (US32D)	W	-	2
				

Backset:

2-3/4" (70mm)	2	standard
2-3/8" (60mm)	G	(optional, cylindrical only)

continued on next page

Door Thickness:

1-1/2" - 1-3/4"	3	standard
1-3/4" - 2-3/8"	4	-
2-3/8" - 3"	6	-
3" - 3-1/2"	7	-
3-1/2" - 4-1/8"	9	-
4-1/8" - 4-3/4"	1	-

Strike:

Standard Strike (Mortise)	M	standard	1
Extended Lip Strike 1-1/2" lip (mortise)	B	-	1
Round Corner Extended Lip Strike 1-1/2" lip (mortise)	C	-	1
No Lip Strike (mortise)	D	-	1
Flat Lip Strike - 7/8" lip (mortise)	E	-	1
Flat Lip Strike - 1-3/16" lip (mortise)	F	-	1
Round Corner Strike 1-3/16" lip (mortise)	R	-	1
ASA strike (cylindrical)	A	-	1

Key Override:

No Key Override	-	standard	1
Key Override, less cylinder*	000X	-	1

Optional Features

Description	Part No.	2022 List	Stock No.	Box Qty.
Outdoor Kit <i>use when the escutcheon is installed on an exterior door (pack of 6)</i>	SP220475-6	\$135.42	120420	6
Door Position Switch (wood openings) <i>RFnet platform only</i>	RFDTCTW18W01	\$65.16	118845	1
Door Position Switch (metal openings) <i>RFnet platform only</i>	RFDTCTS18W01	\$65.16	118838	1
Wireless Antenna <i>RFnet platform only</i> <i>used to convert an SVN lock that is wireless capable to a RFnet lock</i>	RFMODULEW01	\$245.33	195316	1

HS4 Wide Body Product Ordering Notes

* - Key Override: standard straight cam required for 1-1/8" mortise cylinder

Finish Notes

Finish	Description	Armor Front	Strike
US32D	Satin Stainless Steel	US32D	US32D
US32	Bright Stainless Steel	US32D	US32D
US3	Bright Brass (PVD)	US3	US3
US4	Satin Brass (PVD)	US4	US4
BLK	Satin Chrome Black	US32D	US32D
BIO	Satin Stainless Steel with BioCote	US32D	US32D

HS4 Mini

The HS4 Mini is a small footprint but powerful smart lock intended for interior applications

How to Order Guide

HS4	Function	Lock Type	Platform	Finish	Reader Technology	Reader Color	Lever	Backset	Door Thickness	Strike	Key Override		
H HS4 Access Control	M Mini	34 Cylindrical Lock	J SAN/SVN + BLUEnet	300 US3 Polished Brass (PVD)	B Wireless Mifare DESfire +BLE	B Black	A Archer	2 2-3/4" (standard)	3 1-37/64" - 1-3/4" (standard)	A ASA Strike	-		
				400 US4 Satin Brass (PVD)					4 >1-3/4" - 2-3/8"				
				26D US26D Satin Chrome			W White	W Withnell	G 2-3/8" (optional)			6 2-3/8" - 3"	000X Key Override No Core
				260 US26 Bright Chrome								7 3" - 3-1/2"	
				BLK Black								9 3-1/2" - 4-1/8"	
				BIO BioCote								1 4-1/8" - 4-3/4"	

Description	Ordering Codes	2022 List	Stock No.	Box Qty.
-------------	----------------	-----------	-----------	----------

Lock Functions:

Grade 1 Cylindrical Lock Functions:

Storeroom Function (entrance)	HM34	\$1,074.77		1
-------------------------------	------	------------	--	---

Platform:

SVN + BLUEnet	J	standard		
---------------	---	----------	--	--

Finishes:

US26D - Satin Chromium	26D	-		
US26 - Bright Chromium	260	-		
US3 - Bright Brass (PVD)	300	\$60.74		
US4 - Satin Brass (PVD)	400	\$60.74		
BLK - Satin Chrome Black	BLK	\$17.86		
BIO - Satin Chromium BioCote	BIO	\$82.12		

Reader Technology:

Mifare/DESfire + BLE	B	standard		
----------------------	---	----------	--	--

Reader Color:

Black	B	-		
White	W	-		

continued on next page

Lever Styles:

Archer	Available in US32D, US4, Black and BioCote (US32D)	A	-	2
				
August	Available in US32D, US32, US3, US4, Black and BioCote (US32D)	U	-	2
				
Withnell	Available in US32D, US4, Black and BioCote (US32D)	W	-	2
				

Backset:

2-3/4" (70mm)	2	standard
2-3/8" (60mm)	G	-
3-3/4" (95mm)	3	-
5" (127mm)	5	-

Door Thickness:

1-37/64" - 1-3/4"	3	standard
1-3/4" - 2-3/8"	4	-
2-3/8" - 3"	6	-
3" - 3-1/2"	7	-
3-1/2" - 4-1/8"	9	-
4-1/8" - 4-3/4"	1	-

Strike:

ASA strike (cylindrical)	A	-	1
--------------------------	---	---	---

Key Override:

No Key Override	-	standard	
Key Override, less cylinder*	000X	-	1

HS4 Mini Product Ordering Notes

Key Override - requires 3960 conventional cylinder with tailpiece #9. Installed in lever.

Finish Notes

Finish	Description	Armor Front	Strike
US26D	Satin Chromium	US26D	US26D
US26	Bright Chromium	US26D	US26D
US3	Bright Brass (PVD)	US3	US3
US4	Satin Brass (PVD)	US3	US3
BLK	Satin Chrome Black	US26D	US26D
BIO	Satin Stainless Steel with BioCote	US26D	US26D

Optional Features

Description	Part No.	2022 List	Stock No.	Box Qty.
Door Spacers - for use on a 1-3/8" thick door				
Single Pack	SP226233.01-BM	\$12.02		1
Double Pack	SP226233.02-BM	\$0.00		2

HS4 AElement

The HS4 AElement provides an elegant, customizable design for most interior openings

How to Order Guide

HS4	Function	Lock Type	Platform	Lever Finish	Reader Technology	Reader & Battery Cover Color	Lever	Backset	Door Thickness	Strike	Handing	Lock Offset	DPS
H HS4 Access Control	A Entrance	38 Mortise Lock	J SAN/SVN + BLUEnet <i>for BLUEnet, specify BLE in Credential variable</i>	300 US3 Polished Brass	9 Mifare DESfire	A Black Light Gray	0 No Levers By Others (must specify)	2 2-3/4" (standard)	3 1-3/8" - 1-3/4"	M Standard Strike	L Left Hand	A 3/4" - 1-3/16" (standard)	D (standard)
				400 US4 Satin Brass		F Black Anthracite (BLK)			4 >1-3/4" - 2-1/8"				
				(strike & Armor front US3)		G Black Gold			5 2-1/8" - 2-9/16"				
				B RFnet Capable		H Black Iron Blue			6 2-9/16" - 3"				
				C RFnet		J White Light Gray			7 3" - 3-3/8"				
						K White Anthracite (BLK)			8 3-3/8" - 3-3/4"				
	L White Gold		9 3-3/4" - 4-1/8"										
	M White Iron Blue		0 4-1/8" - 4-1/2"										
	U Thumb Turn Privacy w/ Deadbolt		320 US32D Satin Stainless Steel		B Mifare DESfire +BLE (Only available with BLUEnet)	D Joshua	1 4-1/8" - 4-1/2"		R Right Hand		B 1-3/16" - 1-5/8"		
			320 US32 Bright Stainless Steel			L William							
			(strike & Armor front US32D)	W Withnell									
			BLK Black (strike & Armor front US32D)										

Description	Ordering Codes	2022 List	Stock No.	Box Qty.
-------------	----------------	-----------	-----------	----------

Lock Function:

Grade 1 Electrified Mortise Lock Functions:

Storeroom Function (entrance) mortise without deadbolt	HA38	\$1,082.93		1
Electronic Privacy mortise without deadbolt	HC38	\$1,101.65		1
Thumbturn Privacy mortise with deadbolt	HU38	\$1,101.65		1

Levers are priced separately on the next page

Platform:

SVN + BLUEnet (specify "B" as Credential variable)	J	\$60.74
SVN + RFnet Capable	B	-
SVN + RFnet Ready	C	\$223.44

AElement - BLE is only compatible with SVN + BLUEnet platforms

Lever Finish:

US32D - Satin Stainless Steel	32D	-
US32 - Bright Stainless Steel	320	\$38.56
US3 - Bright Brass (PVD)	300	\$38.56
US4 - Satin Brass (PVD)	400	-
BLK - Satin Chrome Black	BLK	\$44.40

Finish applies to the lock trim (i.e. thumb turn). See Finish Notes to see which finishes are supplied.

continued on next page



Reader Technology:

Mifare/DESfire	9	standard	
Mifare/DESfire + BLE (SVN + BLUEnet Only) <i>BLE is included in SVN+BLUEnet pricing</i>	B	-	

Reader & Battery Cover Color:

Black Reader w/ Light gray Battery Cover	A	-	1
Black Reader w/ Anthracite (black) Battery Cover	F	-	1
Black Reader w/ Gold Battery Cover	G	-	1
Black Reader w/ Iron Blue Battery Cover	H	-	1
White Reader w/ Light gray Battery Cover	J	-	1
White Reader w/ Anthracite Battery Cover	K	-	1
White Reader w/ Gold Battery Cover	L	-	1
White Reader w/ Iron Blue Battery Cover	M	-	1

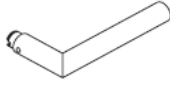
Lever Styles: *(when ordering AElement levers, specify handing)*

No Lever, No Thumbturn <i>additional customer levers on next page</i>	0	-	
Archer	A	-	
US32D - Satin Stainless Steel		\$217.31	2
US4 - Satin Brass		\$217.31	2
			
Joshua	D	-	
US32D - Satin Stainless Steel		\$217.31	2
US32 - Bright Stainless Steel		\$217.31	2
US3 - Bright Brass		\$217.31	2
US4 - Satin Brass		\$217.31	2
BLK - Satin Chrome Black		\$217.31	2
			
William	L	-	
US32D - Satin Stainless Steel		\$217.31	2
US32 - Bright Stainless Steel		\$217.31	2
US3 - Bright Brass		\$217.31	2
US4 - Satin Brass		\$217.31	2
BLK - Satin Chrome Black		\$217.31	2
			
Withnell	W	-	
US32D - Satin Stainless Steel		\$217.31	2
US4 - Satin Brass		\$217.31	2
			

Custom levers can be found on the next page and are ordered as a separate line item

Backset:

2-3/4" (70mm)	2	standard	
---------------	---	----------	--

continued on next page

Door Thickness:

1-3/8" - 1-3/4"	3	standard
1-3/4" - 2-1/8"	4	-
2-1/8" - 2-9/16"	5	-
2-9/16" - 3"	6	-
3" - 3-3/8"	7	-
3-3/8" - 3-3/4"	8	-
3-3/4" - 4-1/8"	9	-
4-1/8" - 4-1/2"	0	-
4-1/2" - 4-15/16"	1	-

Strike:

Standard Strike (Mortise)	M	standard	1
---------------------------	---	----------	---

Refer to How to Order guide for handing, lock offset, and DPS variables

Optional Features

Description	Part No.	2022 List	Stock No.	Box Qty.
RFnet Antenna				
<i>RFnet platform only</i>	RFMODULEW02	\$245.44		1
<i>used to convert an SVN lock that is wireless capable to a RFnet lock</i>				
Optional Strikes				
1-1/2" Extended Lip Strike, Square Corner (US32D)	CE1T1AL80IM	\$37.49	68368	1
1-3/4" Extended Lip Strike, Square Corner (US32D)	CE1T1AL40IM	\$37.49	68369	1
2" Extended Lip Strike, Square Corner (US32D)	CE1T1AL50IM	\$36.41	68363	1
<i>doors over 1-3/4" may require an extended lip strike (sold separately)</i>				

HS4 AElement Product Ordering Notes

Door Monitoring - all AElement locks come standard with a door position switch when ordered as RFnet

Key Override - please contact Hager Technical Service for more information

Finish Notes

Finish	Description	Armor Front	Strike
US32D	Satin Stainless Steel	US32D	US32D
US32	Bright Stainless Steel	US32D	US32D
US3	Bright Brass (PVD)	US3	US3
US4	Satin Brass (PVD)	US3	US3
BLK	Satin Chrome Black	US32D	US32D

continued on next page

Additional Custom Levers

order lock as "No Lever, No Thumbturn"









Custom Lever

Part No.	2022 List	Box Qty.
----------	-----------	----------

see below

\$265.97

2

		US32D	US32	US3
		Satin Stainless Steel	Bright Stainless Steel	Bright Brass (PVD)
	with Thumbturn	2-679-0984	2-679-0985	2-679-0986
	without Thumbturn	2-679-0981	2-679-0982	2-679-0983
	with Thumbturn	2-679-0990	2-679-0991	2-679-0992
	without Thumbturn	2-679-0987	2-679-0988	2-679-0989
	with Thumbturn	2-679-0973	2-679-0974	2-679-0975
	without Thumbturn	2-679-0944	2-679-0954	2-679-0972
	with Thumbturn	2-679-0947	2-679-0979	2-679-0980
	without Thumbturn	2-679-0976	2-679-0977	2-679-0978

HS4 AElement Fusion

The HS4 AElement Fusion offers a simplistic design with clean lines.

How to Order Guide

HS4	Function	Lock Type	Platform	Lever Finish	Reader Technology	Reader & Battery Cover Color	Lever	Backset	Door Thickness	Strike	Handing	Lock Offset	DPS
H HS4 Access Control	V Entrance	38 Mortise Lock	J SAN/SVN + BLUEnet	300 US3 Polished Brass	B Mifare DESfire +BLE	B Black	0 No Levers By Others (must specify)	2 2-3/4" (standard)	3 1-5/8" - 1-3/4"	M Standard Strike	L Left Hand	A 3/4" - 1-3/16" (standard)	D (standard)
				400 US4 Satin Brass <i>(strike & Armor front US3)</i>			A Archer		4 1-3/4" - 2-1/8"		P Left Hand Reverse		
				32D US32D Satin Stainless Steel			D Joshua		5 2-1/8" - 2-9/16"		R Right Hand		
	320 US32 Bright Stainless Steel <i>(strike & Armor front US32D)</i>			L William			6 2-9/16" - 2-3/4"		V Right Hand Reverse				
	BLK Black <i>(strike & Armor front US32D)</i>			W Withnell									

Description	Ordering Codes	2022 List	Stock No.	Box Qty.
-------------	----------------	-----------	-----------	----------

Lock Function:

Grade 1 Electrified Mortise Lock Functions:

Storeroom Function (entrance) mortise without deadbolt	HV38	\$1,231.34		1
---	------	------------	--	---

Thumbturn Privacy mortise with deadbolt	HW38	\$1,248.87		1
--	------	------------	--	---

Levers are priced separately on the next page

Platform:

SVN + BLUEnet	J	standard		
---------------	---	----------	--	--

Front Plate Finishes:

US32D - Satin Stainless Steel	32D	-		
US32 - Bright Stainless Steel	320	\$38.56		
US3 - Bright Brass (PVD)	300	\$38.56		
US4 - Satin Brass (PVD)	400	-		
BLK - Satin Chrome Black	BLK	\$44.40		

Finish applies to the lock trim (i.e. thumb turn). See Finish Notes to see which finishes are supplied.

Reader Technology:

Mifare/DESfire + BLE	B	standard		
----------------------	---	----------	--	--



BLE is required for BLUEnet

Reader & Battery Cover Color:

Black Reader	B	-		1
White Reader	W	-		1

continued on next page

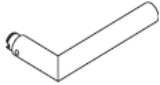
Lever Styles: *(when ordering AElement levers, specify handing)*

No Lever, No Thumbturn		0	-	
Archer		A	-	
US32D - Satin Stainless Steel			\$217.31	2
US4 - Satin Brass			\$217.31	2
Joshua		D	-	
US32D - Satin Stainless Steel			\$217.31	2
US32 - Bright Stainless Steel			\$217.31	2
US3 - Bright Brass			\$217.31	2
US4 - Satin Brass			\$217.31	2
BLK - Satin Chrome Black			\$217.31	2
William		L	-	
US32D - Satin Stainless Steel			\$217.31	2
US32 - Bright Stainless Steel			\$217.31	2
US3 - Bright Brass			\$217.31	2
US4 - Satin Brass			\$217.31	2
BLK - Satin Chrome Black			\$217.31	2
Withnell		W	-	
US32D - Satin Stainless Steel			\$217.31	2
US4 - Satin Brass			\$217.31	2

Custom levers can be found in the AElement section and are ordered as a separate line item

Backset:

2-3/4" (70mm)	2	standard
---------------	---	----------

Door Thickness:

1-3/8" - 1-3/4"	3	standard
1-3/4" - 2-1/8"	4	-
2-1/8" - 2-9/16"	5	-
2-9/16" - 3"	6	-
3" - 3-3/8"	7	-
3-3/8" - 3-3/4"	8	-
3-3/4" - 4-1/8"	9	-
4-1/8" - 4-1/2"	0	-
4-1/2" - 4-15/16"	1	-

Strike:

Standard Strike (Mortise)	M	standard	1
---------------------------	---	----------	---

Refer to How to Order guide for handing, lock offset, and DPS variables

Fusion Product Ordering Notes

* - Key Override: mechanical override is available. Contact Hager Technical Service for cylinder options

continued on next page

Finish Notes

Finish	Description	Armor Front	Strike
US32D	Satin Stainless Steel	US32D	US32D
US32	Bright Stainless Steel	US32D	US32D
US3	Bright Brass (PVD)	US3	US3
US4	Satin Brass (PVD)	US3	US3
BLK	Satin Chrome Black	US32D	US32D

HS4 GEO Mortise

The HS4 GEO mortise is ideal for retrofit locks where a traditional escutcheon is not practical

How to Order Guide

HS4	GEO Type	Platform	Finish	Reader Technology	Reader Color	IP Rating	Cylinder Length	
H HS4 Access Control	G02 GEO Mortise	A SAN/SVN	300 US3 Polished Brass	9 Mifare DESfire	B Black	00000A IP55 (standard)	2 1-1/4"	
			400 US4 Satin Brass				3 1-3/8"	
			26D US26D Satin Chrome				4 1-1/2"	
		C RFnet	260 US26 Bright Chrome		W White		00000B IP66	5 1-5/8"
			BLK Black					6 1-3/4"
			BIO BioCote					7 2"

Description	Ordering Codes	2022 List	Stock No.	Box Qty.
Mortise profile electronic cylinder Standard cam installed (for mortise GEO Cylinders) and a spare Adams Rite cam in the box.	HG02	\$647.23		1

Platform:

RFID SVN	A	standard
SVN + RFnet	C	\$178.75

Finishes:

US26D - Satin Chromium	26D	-
US26 - Bright Chromium	260	-
US3 - Bright Brass	300	\$60.79
US4 - Satin Brass	400	\$60.79
BLK - Satin Chrome Black	BLK	\$17.92
BIO - Satin Chromium BioCote	BIO	\$82.17

Reader Technology:

Mifare/DESfire	9	standard
----------------	---	----------

Reader Color:

Black	B	-
White	W	-

IP Rating:

IP55 (protection from dust infiltration)	00000A	standard
IP66 (protection from dust infiltration and projected water streams)	00000B	\$35.50

continued on next page

Mortise Cylinder Length:

1-1/4" (32mm)	2	-
1-3/8" (35mm)	3	-
1-1/2" (38mm)	4	-
1-5/8" (41mm)	5	-
1-3/4" (44mm)	6	-
2" (50mm)	7	-

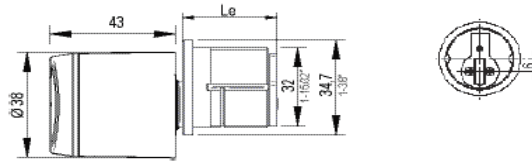

HS4 GEO Rim

The HS4 GEO rim is ideal for most surface mounted locks and exit devices

How to Order Guide

HS4	GEO Type	Platform	Finish	Reader Technology	Reader Color	IP Rating
H HS4 Access Control	G01 GEO Rim Cylinder	A SAN/SVN	300 US3 Polished Brass	9 Mifare DESfire	B Black	00000A IP55 (standard)
			400 US4 Satin Brass			
			26D US26D Satin Chrome			
		C RFnet	260 US26 Bright Chrome		W White	00000B IP66
			BLK Black			
			BIO BioCote			

Description	Ordering Codes	2022 List	Stock No.	Box Qty.
Rim profile electronic cylinder	HG01	\$647.23		1

Platform:

RFID SVN	A	standard
SVN + RFnet	C	\$178.75

Finishes:

US26D - Satin Chromium	26D	-
US26 - Bright Chromium	260	-
US3 - Bright Brass	300	\$60.79
US4 - Satin Brass	400	\$60.79
BLK - Satin Chrome Black	BLK	\$17.92
BIO - Satin Chromium BioCote	BIO	\$82.17

Reader Technology:

Mifare/DESfire	9	standard
----------------	---	----------

Reader Color:

Black	B	-
White	W	-

continued on next page

IP Rating:

IP55 (protection from dust infiltration)

00000A

standard

IP66 (protection from dust infiltration and projected water streams)

00000B

\$35.50

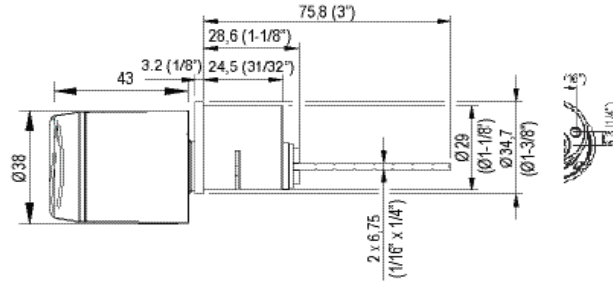

HS4 GEO Deadbolt (Single Cylinder)

The HS4 GEO deadbolt is ideal for installations where audit trails are needed at fire rated deadlock openings

How to Order Guide

HS4	GEO Type	Platform	Finish	Reader Technology	Reader Color	Backset	Door Thickness	IP Rating	Deadbolt Type
H HS4 Access Control	G32 HG03 GEO (20-Minute UL Listed) + 3215 Deadlock + Conversion Kit	A SAN/SVN	300 US3 Polished Brass	9 Mifare DESfire	B Black	0G 2-3/8"	3 1-3/8" to 1-3/4"	00A IP55 (standard)	K Single Cylinder 15 Function
			400 US4 Satin Brass						
		C RFnet	260 US26 Polished Chrome		W White	02 2-3/4"		00B IP66	L Classroom 18 Function
			26D US26D Satin Chrome						

Description	Ordering Codes	2022 List	Stock No.	Box Qty.
3215 Deadlock + Conversion Kit + GEO	HG32	\$773.41		1 GEO 1 kit 1 deadlock
Platform:				
RFID SVN	A	standard		
SVN + RFnet	C	\$178.75		
Finishes:				
US26D - Satin Chromium	26D	-		
US26 - Bright Chromium	260	-		
US3 - Bright Brass	300	\$60.79		
US4 - Satin Brass	400	\$60.79		
Reader Technology:				
Mifare/DESfire	9	standard		
Reader Color:				
Black	B	-		
White	W	-		
Backset:				
2-3/4" (70mm)	02	standard		
2-3/8" (60mm)	0G	-		
Door Thickness:				
1-3/8" - 1-3/4"	3	standard		
IP Rating:				
IP55 (protection from dust infiltration)	00A	standard		
IP66 (protection from dust infiltration and projected water streams)	00B	\$35.50		
Deadbolt Type:				
Single Cylinder (15 Function) (uses Hager part no. 3215)	K	-		
Classroom (18 Function)	L	-		

HS4 GEO Deadbolt (Double Cylinder)

The HS4 GEO deadbolt is ideal for installations where audit trails are needed at deadlock openings

How to Order Guide

HS4	GEO Type	Platform	Finish	Reader Technology	Reader Color	Backset	Door Thickness	IP Rating	Deadbolt Type
H HS4 Access Control	G32 HG03 GEO + Deadlock	A SAN/SVN	300 US3 Polished Brass	9 Mifare DESfire	B Black	0G 2-3/8"	3 1-3/8" to 1-3/4"	00A IP55 (standard)	M Double Cylinder 14 Function
			400 US4 Satin Brass						
		C RFnet	260 US26 Polished Chrome		00B IP66				
			26D US26D Satin Chrome						

Description	Ordering Codes	2022 List	Stock No.	Box Qty.
Deadlock + GEO + GEO	HG32	\$1,559.58		2 GEO cylinders
<u>Platform:</u>				
RFID SVN	A	standard		1 deadlock
SVN + RFnet	C	\$355.74		
<u>Finishes:</u>				
US26D - Satin Chromium	26D	-		
US26 - Bright Chromium	260	-		
US3 - Bright Brass	300	\$121.53		
US4 - Satin Brass	400	\$121.53		
<u>Reader Technology:</u>				
Mifare/DESfire	9	standard		
<u>Reader Color:</u>				
Black	B	-		
White	W	-		
<u>Backset:</u>				
2-3/8"	0G	standard		
2-3/4"	02	-		
<u>Door Thickness:</u>				
1-3/8" - 1-3/4"	3	standard		
<u>IP Rating:</u>				
IP55 (protection from dust infiltration)	00A	standard		
IP66 (protection from dust infiltration and projected water streams)	00B	\$71.00		

continued on next page

Deadbolt Type:

Double Cylinder (14 Function)

M

-

1

double cylinder requires two GEO cylinders
deadbolt operated by card from either side
backset 2-3/4" (70mm) or 2-3/8" (60mm)
GEO is available in US26D only

HS4 GEO with Interconnected Lock & Conversion

The HS4 GEO's compatibility allows it to be used with Hager's 3710 Interconnected

How to Order Guide

HS4	GEO Type	Platform	Finish	Reader Technology	Reader Color	Lever Style	Backset	Door Thickness	Strikes	IP Rating
H HS4 Access Control	G37 HG03 GEO (20-Minute UL) + 3710 Interconnected + Conversion Kit	A SAN/SVN	300 US3 Polished Brass	9 Mifare DESfire	B Black	A Archer	G 2-3/8"	3 1-3/8" to 1-3/4"	S Full Lip Sq Corner	A IP55 (standard)
			400 US4 Satin Brass							
			260 US26 Polished Chrome							
		C RFnet	26D US26D Satin Chrome		W White	W Withnell	2 2-3/4"		L Full Lip Rd Corner	B IP66
			BLK Black							
			BIO BioCote							

Description	Ordering Codes	2022 List	Stock No.	Box Qty.
3710 Interconnected + Conversion Kit + GEO	HG37	\$876.17		1 GEO 1 kit 1 lock

Platform:

RFID SVN	A	standard
SVN + RFnet	C	\$178.75

Finishes:

US26D - Satin Chromium	26D	-
US26 - Bright Chromium	260	-
US3 - Bright Brass	300	\$60.79
US4 - Satin Brass	400	\$60.79
BLK - Satin Chrome Black	BLK	\$17.92
BIO - Satin Chromium BioCote (GEO only)	BIO	\$82.17

Reader Technology:



Mifare/DESfire	9	standard
----------------	---	----------

Reader Color:

Black	B	-
White	W	-

continued on next page

Lever Styles:

Archer	A	-	2
			
August	U	-	2
			
Withnell	W	-	2
			

Backset:

2-3/8"	G	standard	
2-3/4"	2	-	

Door Thickness:

1-3/8" - 1-3/4"	3	standard	
-----------------	---	----------	--

Strike:

Full Lip Square Corner	S	-	1
Full Lip Round Corner	L	-	1
Tee Strike	T	standard	1

IP Rating:

IP55 (protection from dust infiltration)	A	standard	
IP66 (protection from dust infiltration and projected water streams)	B	\$35.50	

HS4 GEO with Conversion

The HS4 GEO's compatibility allows it to be used with Hager's 3700 Series Interconnected locks and 3200 Series deadlocks (20-Minute Fire Rating)

How to Order Guide

HS4	GEO Type	Platform	Finish	Reader Technology	Reader Color	IP Rating
H HS4 Access Control	G03 HG03 GEO + Conversion Kit	A SAN/SVN	300 US3 Polished Brass	9 Mifare DESfire	B Black	00000A IP55 (standard)
			400 US4 Satin Brass			
			260 US26 Polished Chrome			
		C RFnet	26D US26D Satin Chrome		W White	00000B IP66
			BLK Black			
			BIO BioCote			

Description	Ordering Codes	2022 List	Stock No.	Box Qty.
Conversion Kit + GEO	HG03	\$722.03		1 GEO 1 kit

Platform:

RFID SVN	A	standard
SVN + RFnet	C	\$178.75

Finishes:

US26D - Satin Chromium	26D	-
US26 - Bright Chromium	260	-
US3 - Bright Brass	300	\$60.79
US4 - Satin Brass	400	\$60.79
BLK - Satin Chrome Black	BLK	\$17.92
BIO - Satin Chromium BioCote	BIO	\$82.17

Reader Technology:

Mifare/DESfire	9	standard
----------------	---	----------

Reader Color:

Black	B	-
White	W	-

IP Rating:

IP55 (protection from dust infiltration)	00000A	standard
IP66 (protection from dust infiltration and projected water streams)	00000B	\$35.50

Conversion Kit Only

Required for GEO installation with Hager's 3700 (3710) and 3200 (3215)

GEO and Lock will be supplied separately			
US3	2-639-0320	\$32.15	98363
US4	2-639-0321	\$32.15	98344
US26	2-639-0325	\$32.15	98331
US26D	2-639-0326	\$32.15	98320

For lock specifications, please refer to the Hager 3700 Series, model 3710 or 3200 Series, model 3215

HS4 GEO Padlock

The HS4 GEO padlock is a unique product that allows users access control capabilities on padlocks deployed throughout a building

How to Order Guide

HS4	GEO Type	Platform	Finish	Reader Technology	Reader Color	IP Rating	Shackle Size & Length
H HS4 Access Control	G10 GEO Padlock	A SAN/SVN	260 US26 Bright Chrome	9 Mifare DESfire	B Black	00000B IP66 (standard)	A 48mm Padlock Shackle Length: 1-3/16" Shackle Diameter: 8mm
							B 48mm Padlock Shackle Length: 2-3/8" Shackle Diameter: 8mm
		C 48mm Padlock Shackle Length: 3-9/16" Shackle Diameter: 8mm					
	C RFnet	W White			D 58mm Padlock Shackle Length: 1-3/16" Shackle Diameter: 10mm		
					E 58mm Padlock Shackle Length: 2-3/8" Shackle Diameter: 10mm		
					F 58mm Padlock Shackle Length: 3-9/16" Shackle Diameter: 10mm		

Description	Ordering Codes	2022 List	Stock No.	Box Qty.
Geo Padlock	HG10	\$885.53		1
Platform:				
RFID SVN	A	standard		
SVN + RFnet	C	\$178.75		
Finishes:				
US26 - Bright Chromium	260	-		
Reader Technology:				
Mifare/DESfire	9	standard		
Reader Color:				
Black	B	-		
White	W	-		
IP Rating:				
IP66 (protection from dust infiltration and projected water streams)	00000B	standard		

continued on next page

Shackle Size & Length

48mm Padlock: 1-3/16" (30 mm) (with 8mm shackle diameter)	A	-
48mm Padlock: 2-3/8" (60 mm) (with 8mm shackle diameter)	B	-
48mm Padlock: 3-9/16" (90 mm) (with 8mm shackle diameter)	C	-
58mm Padlock: 1-3/16" (30 mm) (with 10 mm shackle diameter)	D	\$57.28
58mm Padlock: 2-3/8" (60 mm) (with 10 mm shackle diameter)	E	\$57.28
58mm Padlock: 3-9/16" (90 mm) (with 10 mm shackle diameter)	F	\$57.28

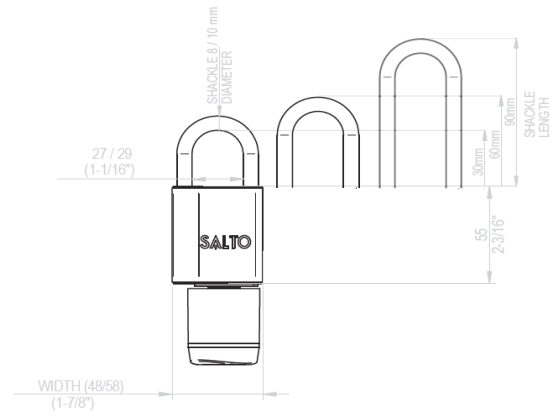
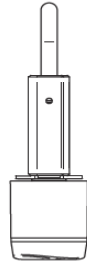
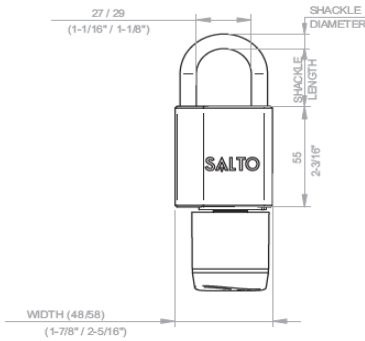

HS4 GEO Cam Lock

The HS4 GEO cam provides additional security to installed cam locks

How to Order Guide

HS4	GEO Type	Platform	Finish	Reader Technology	Reader Color	IP Rating	Body Length & Cam Height
H HS4 Access Control	G11 GEO Cam Lock	A SAN/SVN	300 US3 Polished Brass	9 Mifare DESfire	B Black	00000A IP55 (standard)	G Body Length: 5/8" Cam Height: 1-1/8"
			400 US4 Satin Brass				
			26D US26D Satin Chrome				
		C RFnet	260 US26 Bright Chrome		W White	00000B IP66	I Body Length: 7/8" Cam Height: 1-1/8"
			BLK Black				
			BIO BioCote				

Description	Ordering Codes	2022 List	Stock No.	Box Qty.
Cam lock electronic cylinder	HG11	\$647.23		1
Platform:				
RFID SVN	A	standard		
SVN + RFnet	C	\$178.75		
Finishes:				
US26D - Satin Chromium	26D	-		
US26 - Bright Chromium	260	-		
US3 - Bright Brass (PVD)	300	\$60.79		
US4 - Satin Brass (PVD)	400	\$60.79		
BLK - Satin Chrome Black	BLK	\$17.92		
BIO - Satin Chromium BioCote	BIO	\$82.17		
Reader Technology:				
Mifare/DESfire	9	standard		
Reader Color:				
Black	B	-		
White	W	-		
IP Rating:				
IP55 (protection from dust infiltration)	00000A	standard		
IP66 (protection from dust infiltration and projected water streams)	00000B	\$35.50		

continued on next page

Body Length & Cam Height

5/8" Body Length / 1-1/8" CAM Height	G	-	1
5/8" Body Length / 1-9/16" CAM Height	H	-	1
7/8" Body Length / 1-1/8" CAM Height	I	-	1
7/8" Body Length / 1-9/16" CAM Height	J	-	1

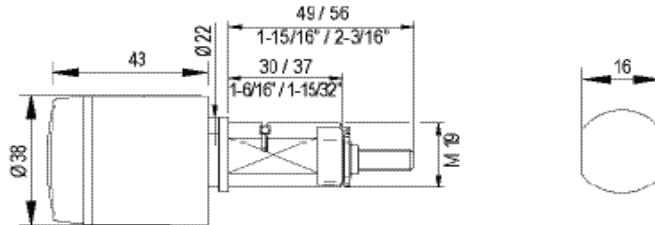

HS4 NEO Mortise

The HS4 NEO mortise is ideal for retrofit locks where a traditional escutcheon is not practical

How to Order Guide

HS4	NEO Type	Platform	Finish	Reader Technology	Reader Color	IP Rating	Cylinder Length				
H HS4 Access Control	N02 NEO Mortise Cylinder	J SAN/SVN + BLUEnet	300 US3 Polished Brass (PVD)	B Wireless Mifare DESfire +BLE	B Black	00000A IP55 (standard)	2 1-1/4"				
			400 US4 Satin Brass (PVD)				3 1-3/8"				
			26D US26D Satin Chrome				4 1-1/2"				
							260 US26 Bright Chrome		W White	00000B IP66	5 1-5/8"
							BLK Black				6 1-3/4"
							BIO BioCote				7 2"

Description	Ordering Codes	2022 List	Stock No.	Box Qty.
Mortise profile electronic cylinder	HN02	\$674.68		1
Standard cam installed (for mortise NEO Cylinders).				

Platform:

SVN + BLUEnet	J	standard
---------------	---	----------

Finishes:

US26D - Satin Chromium	26D	-
US26 - Bright Chromium	260	-
US3 - Bright Brass	300	\$60.79
US4 - Satin Brass	400	\$60.79
BLK - Satin Chrome Black	BLK	\$17.92
BIO - Satin Chromium BioCote	BIO	\$82.17

Reader Technology:

Mifare/DESfire + BLE	B	standard
----------------------	---	----------

Reader Color:

Black	B	-
White	W	-

IP Rating:

IP55 (protection from dust infiltration)	00000A	standard
IP66 (protection from dust infiltration and projected water streams)	00000B	\$35.50

continued on next page

Mortise Cylinder Length:

1-1/4" (32mm)	2	-
1-3/8" (35mm)	3	-
1-1/2" (38mm)	4	-
1-5/8" (41mm)	5	-
1-3/4" (44mm)	6	-
2" (50mm)	7	-

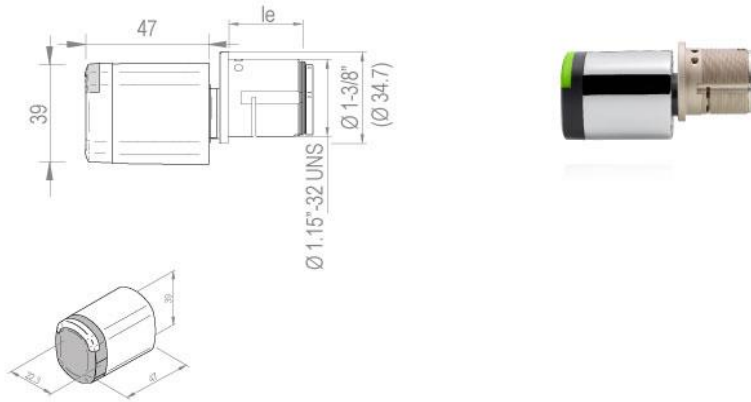

HS4 NEO Rim

The HS4 NEO rim is ideal for most surface mounted locks and exit devices

How to Order Guide

HS4	NEO Type	Platform	Finish	Reader Technology	Reader Color	IP Rating
H HS4 Access Control	N01 NEO Rim Cylinder	J SAN/SVN + BLUEnet	300 US3 Polished Brass (PVD)	B Wireless Mifare DESfire +BLE	B Black	00000A IP55 (standard)
			400 US4 Satin Brass (PVD)			
			26D US26D Satin Chrome			
			260 US26 Bright Chrome		W White	00000B IP66
			BLK Black			
			BIO BioCote			

Description	Ordering Codes	2022 List	Stock No.	Box Qty.
Rim profile electronic cylinder	HN01	\$674.68		1
Platform:				
SVN + BLUEnet	J	standard		
Finishes:				
US26D - Satin Chromium	26D	-		
US26 - Bright Chromium	260	-		
US3 - Bright Brass	300	\$60.79		
US4 - Satin Brass	400	\$60.79		
BLK - Satin Chrome Black	BLK	\$17.92		
BIO - Satin Chromium BioCote	BIO	\$82.17		
Reader Technology:				
Mifare/DESfire + BLE	B	standard		
Reader Color:				
Black	B	-		
White	W	-		
IP Rating:				
IP55 (protection from dust infiltration)	00000A	standard		
IP66 (protection from dust infiltration and projected water streams)	00000B	\$35.50		

continued on next page

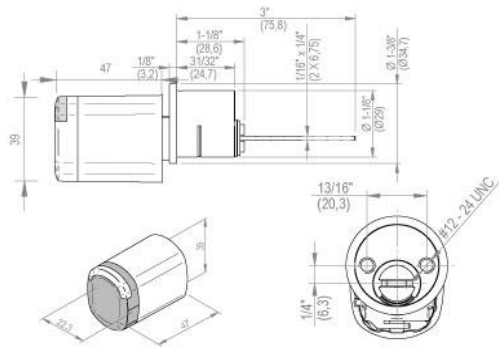

Nxi

HS4 NEO Deadbolt (Single Cylinder)

The HS4 NEO deadlock is ideal for installations where audit trails are needed at fire rated deadlock openings

How to Order Guide

HS4	NEO Type	Platform	Finish	Reader Technology	Reader Color	Backset	Door Thickness	IP Rating	Deadbolt Type
H HS4 Access Control	N32 HN03 NEO + 3215 Deadlock + Conversion Kit	J SAN/SVN + BLUEnet	300 US3 Polished Brass (PVD)	B Wireless Mifare DESfire +BLE	B Black	0G 2-3/8"	3 1-3/8" to 1-3/4"	00A IP55 (standard)	K Single Cylinder 15 Function
			400 US4 Satin Brass (PVD)						
			26D US26D Satin Chrome		W White	02 2-3/4"		00B IP66	L Classroom 18 Function
			260 US26 Bright Chrome						

Description	Ordering Codes	2022 List	Stock No.	Box Qty.
Deadlock + NEO	HN32	\$907.36		1

Platform:

SVN + BLUEnet	J	standard
---------------	---	----------

Finishes:

US26D - Satin Chromium	26D	-
US26 - Bright Chromium	260	-
US3 - Bright Brass	300	\$60.79
US4 - Satin Brass	400	\$60.79

Reader Technology:

Mifare/DESfire + BLE	B	standard
----------------------	---	----------

Reader Color:

Black	B	-
White	W	-

Backset:

2-3/4" (70mm)	02	standard
2-3/8" (60mm)	0G	-

Door Thickness:

1-3/8" - 1-3/4"	3	standard
-----------------	---	----------

IP Rating:

IP55 (protection from dust infiltration)	00A	standard
IP66 (protection from dust infiltration and projected water streams)	00B	\$35.50

Deadbolt Type:

Single Cylinder (15 Function)	K	-
Classroom (18 Function)	L	-

HS4 NEO Deadbolt (Double Cylinder)

The HS4 NEO deadbolt is ideal for installations where audit trails are needed at deadlock openings

How to Order Guide

HS4	NEO Type	Platform	Finish	Reader Technology	Reader Color	Backset	Door Thickness	IP Rating	Deadbolt Type
H HS4 Access Control	N32 HN03 NEO + Deadlock	J SAN/SVN + BLUEnet	300 US3 Polished Brass (PVD)	B Wireless Mifare DESfire +BLE	B Black	0G 2-3/8"	3 1-3/8" to 1-3/4"	00A IP55 (standard)	M Double Cylinder 14 Function
			400 US4 Satin Brass (PVD)						
			26D US26D Satin Chrome		W White	02 2-3/4"		00B IP66	
			260 US26 Bright Chrome						

Description	Ordering Codes	2022 List	Stock No.	Box Qty.
Deadlock + NEO + NEO	HN32	\$1,658.88		2 NEO cylinders 1 deadlock

Platform:

SVN + BLUEnet	J	standard
---------------	---	----------

Finishes:

US26D - Satin Chromium	26D	-
US26 - Bright Chromium	260	-
US3 - Bright Brass	300	\$121.59
US4 - Satin Brass	400	\$121.59

Reader Technology:

Mifare/DESfire + BLE	B	standard
----------------------	---	----------

Reader Color:

Black	B	-
White	W	-

Backset:

2-3/8"	0G	standard
2-3/4"	02	-

Door Thickness:

1-3/8" - 1-3/4"	3	standard
-----------------	---	----------

IP Rating:

IP55 (protection from dust infiltration)	00A	standard
IP66 (protection from dust infiltration and projected water streams)	00B	\$71.00

continued on next page

Deadbolt Type:

Double Cylinder (14 Function)

M

-

1

*double cylinder requires two NEO cylinders
deadbolt operated by card from either side
backset 2-3/4" (70mm) or 2-3/8" (60mm)*

HS4 NEO with Interconnected Lock & Conversion

The HS4 NEO's compatibility allows it to be used with Hager's 3710 Interconnected

How to Order Guide

HS4	NEO Type	Platform	Finish	Reader Technology	Reader Color	Lever Style	Backset	Door Thickness	Strikes	IP Rating
H HS4 Access Control	N37 HN03 NEO + 3710 Interconnected + Conversion Kit	J SAN/SVN + BLUEnet	300 US3 Polished Brass (PVD)	B Wireless Mifare DESfire +BLE	B Black	A Archer	G 2-3/8"	3 1-3/8" to 1-3/4"	S Full Lip Sq Corner	A IP55 (standard)
			400 US4 Satin Brass (PVD)			W Withnell			L Full Lip Rd Corner	
			26D US26D Satin Chrome		W White	U August	2 2-3/4"		T Tee (standard)	B IP66
			260 US26 Bright Chrome							

Description	Ordering Codes	2022 List	Stock No.	Box Qty.
3710 Interconnected + Conversion Kit + NEO	HN37	\$907.36		1 NEO 1 kit 1 lock

Platform:

SVN + BLUEnet	J	Standard
---------------	---	----------

Finishes:

US26D - Satin Chromium	26D	-
US26 - Bright Chromium	260	-
US3 - Bright Brass	300	\$60.79
US4 - Satin Brass	400	\$60.79



Reader Technology:

Mifare/DESfire + BLE	B	standard
----------------------	---	----------

Reader Color:

Black	B	-
White	W	-

Lever Styles:

Archer	A	-	2
			
August	U	-	2
			
Withnell	W	-	2
			

Backset:

2-3/8"	G	standard
2-3/4"	2	-

continued on next page

Door Thickness:

1-3/8" - 1-3/4"	3	standard
-----------------	---	----------

Strike:

Full Lip Square Corner	S	-	1
Full Lip Round Corner	L	-	1
Tee Strike	T	standard	1

IP Rating:

IP55 (protection from dust infiltration)	A	standard
IP66 (protection from dust infiltration and projected water streams)	B	\$35.50

HS4 NEO Cam Lock

The HS4 NEO cam provides additional security to installed cam locks

How to Order Guide

HS4	NEO Type	Platform	Finish	Reader Technology	Reader Color	IP Rating	Body Length & Cam Height
H HS4 Access Control	N11 NEO Cam Lock	J SAN/SVN + BLUEnet	300 US3 Polished Brass (PVD)	B Wireless Mifare DESfire +BLE	B Black	00000A IP55 (standard)	G Body Length: 5/8" Cam Height: 1-1/8"
			400 US4 Satin Brass (PVD)				H Body Length: 5/8" Cam Height: 1-9/16"
			26D US26D Satin Chrome				I Body Length: 7/8" Cam Height: 1-1/8"
			260 US26 Bright Chrome				
			BLK Black				
			BIO BioCote				

Description	Ordering Codes	2022 List	Stock No.	Box Qty.
Cam lock electronic cylinder	HN11	\$674.11		1
Platform:				
SVN + BLUEnet	J	standard		
Finishes:				
US26D - Satin Chromium	26D	-		
US26 - Bright Chromium	260	-		
US3 - Bright Brass	300	\$60.79		
US4 - Satin Brass	400	\$60.79		
BLK - Satin Chrome Black	BLK	\$17.92		
BIO - Satin Chromium BioCote	BIO	\$82.17		
Reader Technology:				
Mifare/DESfire + BLE	B	standard		
Reader Color:				
Black	B	-		
White	W	-		
IP Rating:				
IP55 (protection from dust infiltration)	00000A	standard		
IP66 (protection from dust infiltration and projected water streams)	00000B	\$35.50		

continued on next page

Body Length & Cam Height

5/8" Body Length / 1-1/8" CAM Height	G	-	1
5/8" Body Length / 1-9/16" CAM Height	H	-	1
7/8" Body Length / 1-1/8" CAM Height	I	-	1
7/8" Body Length / 1-9/16" CAM Height	J	-	1

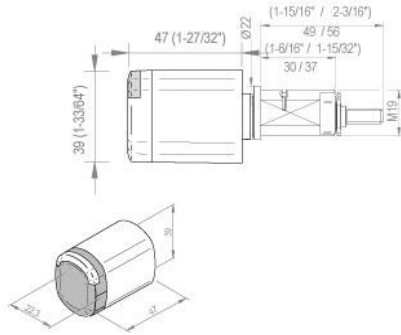

Nx

HS4 GEO Grips

Description	Part No.	2022 List	Stock No.	Box Qty.
ADA Grips				
<i>BioCote antimicrobial protection</i>				
<i>DDA compliant (Disability Discrimination Act)</i>				
Yellow	SALTOGEOGRIPAY	\$53.65	197311	1
Blue	SALTOGEOGRIPAB	\$53.65	197312	1
White	SALTOGEOGRIPAW	\$53.65	197314	1
Black	SALTOGEOGRIPAN	\$53.65	197317	1
Green	SALTOGEOGRIPAG	\$53.65	197319	1
Red	SALTOGEOGRIPAR	\$53.65	197320	1
Rigid Grips				
<i>BioCote antimicrobial protection</i>				
Yellow	SALTOGEOGRIPHY	\$53.65	197321	1
White	SALTOGEOGRIPHW	\$53.65	197324	1
Black	SALTOGEOGRIPHN	\$53.65	196831	1
Green	SALTOGEOGRIPHG	\$53.65	197326	1
Red	SALTOGEOGRIPHR	\$53.65	197327	1

HS4 GEO Installation Tools

Description	Part No.	2022 List	Stock No.	Box Qty.
Cylinder Wrench				
<i>tool used to removed cylinder from lock</i>	SP2207640	\$3.63	146738	1
Installation Cup				
<i>tool used to keep mortise cylinder in position when installing included with all mortise cylinder purchases</i>	SP2204120	\$10.60		1

HS4 NEO Installation Tools

Description	Part No.	2022 List	Stock No.	Box Qty.
Cylinder Wrench				
<i>tool used to removed cylinder from lock</i>	SP2255420	\$40.89		1
Installation Cup				
<i>tool used to keep mortise cylinder in position when installing</i>	SP220412N	\$10.55		1

HS4 Locker Lock

The HS4 locker lock is the perfect solution for gym lockers, visitor lockers, pharmaceutical cabinets, mobile cabinets such as ambulances, and many more

How to Order Guide

HS4	Function	Platform	Finish	Reader Technology	Door Thickness
H HS4 Access Control	L11 Locker Lock	J SAN/SVN + BLUEnet	ANT Anthracite (black)	B Wireless Mifare DESfire +BLE	0001 25/64" to 25/32"
					0002 25/32" to 1-3/16"
			WHT White		0003 1-3/16" to 1-37/64"
					0004 1-37/64" to 1-31/32"

Description	Ordering Codes	2022 List	Stock No.	Box Qty.
HS4 Locker Lock	HL11	\$526.89		1

Platform:

SVN + BLUEnet	J	standard
---------------	---	----------

Finish:

Anthracite (black)	ANT	-
White	WHT	-

all Locker Locks come standard with BioCote protection

Reader Technology:

Mifare/DESfire + BLE	B	standard
----------------------	---	----------

Door Thickness

25/64" - 25/32"	0001	-
25/32" - 1-3/16"	0002	-
1-3/16" - 1-37/64"	0003	-
1-37/64" - 1-31/32"	0004	-

HS4 Exit Device Trim

HS4 Exit trim are supplied with an adaptor kit for easy installation with a Hager 4500 series exit device.

Trim kits for additional manufacturers and models are available. Contact Hager Companies.

How to Order Guide

HS4	Function	Lock Type	Platform	Finish	Reader Technology	Reader Color	Lever	Backset	Door Thickness	Exit Type	Key Override	
H HS4 Access Control	F Exit Trim with Adaptor Kit	45 Hager 4500 Series	D SVN AMOK	300 US3 Polished Brass (PVD)	9 Mifare DESfire (keypad only offered with BLE)	B Black	A Archer	0	3 1-3/4" (standard)	00R Adaptor for RIM Device	-	No Key Override (leave blank)
				400 US4 Satin Brass (PVD)			D Joshua		4 >1-3/4" - 2-3/8"			
			E SVN w/ keypad	32D US32D Satin Stainless Steel			L William		6 2-3/8" - 3"			
			G RFnet w/ keypad	320 US32 Bright Stainless Steel			W White		7 3" - 3-1/2"			
				M SAN/SVN + BLUEnet					BLK Black			
		1 4-1/8" - 4-3/4"										

Description	Ordering Codes	2022 List	Stock No.	Box Qty.
-------------	----------------	-----------	-----------	----------

Exit Device Adaptor Kit

Hager 4500 Series RIM (includes adaptor kit and trim, exit sold separately)	HF45	\$1,711.45		1
Von Duprin 98/99 Series	HF99	\$1,711.45		

Platform:

w/o Keypad

SVN + BLUEnet	M	\$6.18		
SVN w/ AMOK	D	\$221.62		

w/ Keypad (all keypad locks are Bluetooth enabled)

SVN + BLE	E	\$575.38		
RFnet (DPS required - see "Optional Features")	G	\$781.35		

Finishes:

US32D - Satin Stainless Steel	32D	-		
US32 - Bright Stainless Steel	320	\$28.58		
US3 - Bright Brass (PVD)	300	-		
US4 - Satin Brass (PVD)	400	-		
BLK - Satin Chrome Black	BLK	\$60.79		

Reader Technology:

Mifare/DESfire	9	standard		
Mifare/DESfire + BLE	B	\$60.74		

continued on next page

Reader Color:

Black	B	standard
White	W	

Lever Styles:

Archer		Available in US32D	A	-	1
Joshua		Available in US32D, US32, US3, US4, Black and BioCote (US32D)	D	-	1
William		Available in US32D, US32, US3, US4, Black and BioCote (US32D)	L	-	1
Withnell		Available in US32D, US32, US3, US4, Black and BioCote (US32D)	W	-	1

Door Thickness

1-3/4"	03	standard
1-3/4" - 2-3/8"	04	-
2-3/8" - 3"	06	-
3" - 3-1/2"	07	-
3-1/2" - 4-1/8"	09	-
4-1/8" - 4-3/4"	01	-

Exit Type

Adaptor for RIM device	00R	standard
Adaptor for Hager SVR device	00S	-

Key Override:

No Key Override	-	standard
Key Override, less cylinder*	000X	-

Optional Features

Description	Part No.	2022 List	Stock No.	Box Qty.
Outdoor Kit <i>use when the escutcheon is installed on an exterior door (pack of 6)</i>	SP220475-6	\$135.42	120420	6
Door Position Switch (wood doors) <i>RFnet platform only</i>	RFDCTW18W01	\$65.22	118845	1
Door Position Switch (metal doors) <i>RFnet platform only</i>	RFDCTS18W01	\$65.22	118838	1
RX Pigtail Harness for Wireless Exit Trims <i>Used on Hager 4501 Rim with RX to connect to the trim</i>	SP01030-WPB	\$30.10	27068	1

Competitive Exit Kits available for **Von Duprin 98/99, Sargent 8888, Dorma AD4300/AD4400/9300, Corbin Russwin ED5200, Yale 7100, Cal Royal 9800, and Falcon 2500**. Contact Hager Technical Support for more information.

HS4 Storefront

Designed for retrofit storefront applications with Adams Rite, LSDA, and ALPRO deadlatches

How to Order Guide

HS4	Function	Lock Type	Platform	Finish	Reader Technology	Reader Color	Lever	Door Thickness	Latch Guard Finish	IP Rating
H HS4 Access Control	E Entrance	28 Storefront Escutcheon	J SAN/SVN + BLUENet	32D US32D Satin Stainless Steel	B Mifare DESfire +BLE	B Black	A Archer	04 1-3/4" - 2"	32D US32D Satin Stainless Steel	- IP55
	P Push Button Privacy			BLK Black			D Joshua	05 2-1/4" - 2-1/2"	BLK Black	
	F Interior Paddle <i>(not included)</i>			BIO BioCote			W White	W Withnell	07 2-3/4" - 3"	
								08 3-1/4"		

Description	Part No.	2020 List	Case Qty.	Box Qty.
Lock Functions:				
Storeroom Function (entrance) Two levers	HE28	\$1,728.97		1
Push Button Privacy Two levers with electronic privacy	HP28	\$1,728.97		1
Interior Paddle <i>Exterior lever, interior paddle (not included)</i>	HF28	\$1,682.25		1
<i>latchguard is included with all functions</i>				
Platform:				
SVN + BLUENet	J	standard		
Finishes:				
US32D - Satin Stainless Steel	32D	-		
BLK - Satin Chrome Black (William and Withnell levers)	BLK	\$60.79		
BIO - Satin Stainless Steel BioCote	BIO	\$91.13		
Reader Technology:				
Mifare/DESfire + BLE	B	standard		
Reader Color:				
Black	B	-		
White	W	-		

continued on next page

Lever Styles:

Archer	Available in US32D, Black and BioCote (US32D)	A	-	2*
				
Joshua	Available in US32D, Black and BioCote (US32D)	D	-	2*
				
Withnell	Available in US32D, Black and BioCote (US32D)	W	-	2*
				

Door Thickness:

1-3/4" - 2"	04	standard
2-1/4" - 2-1/2"	05	-
2-3/4" - 3"	07	-
3-1/4"	08	-

Latch Guard

US32D - Satin Stainless Steel	32D	-
BLK - Satin Chrome Black (William and Withnell levers)	BLK	-
BIO - Satin Stainless Steel BioCote	BIO	-

IP Rating:

IP55 (protection from dust infiltration)	standard
--	----------

HS4 Storefront Product Ordering Notes

* - two levers are supplied with entrance and privacy functions. One lever is supplied where a deadlatch is used on the interior.

HS4 Glass Door Lock (DIN)

The HS4 Glass Door Lock is an aesthetically appealing locking hardware design that can be implemented in to any SVN and RFnet installation. All glass door locks meet DIN requirements (NOT ANSI).



How to Order Guide

HS4	Function	Lock Type	Platform	Finish	Reader Technology	Lever	Backset	Door Thickness	Strike	Handing
H HS4 Access Control	B Passage	91 Glass Door Lock	A SVN	32D US32D Satin Stainless Steel	9 Mifare DESfire	D Joshua	D 2-1/4" (standard)	0 0-18mm (standard)	G Glass Door Lock Strike	L Left Hand
			B RFnet Capable							P Left Hand Reverse
	E Entrance		C RFnet		B Mifare DESfire +BLE	L William			H Double Door Glass Door Lock Strike	R Right Hand
										V Right Hand Reverse

Description	Ordering Codes	2022 List	Stock No.	Box Qty.
Lock Functions:				
Glass Door Lock Functions:				
Passage Function	HB91	\$1,974.30		1
Storeroom Function (entrance)	HE91	\$2,242.99		1
Platform:				
SVN	A	standard		
SVN + RFnet Capable	B	\$173.53		
SVN + RFnet Ready	C	\$566.02		
Finishes:				
US32D - Satin Stainless Steel	32D	standard		
Reader Technology:				
Mifare/DESfire	9	standard		
Mifare/DESfire + BLE	B	\$68.96		
Reader Color:				
Black	0	standard		

continued on next page

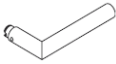
Lever Styles:

Joshua	D	-	2
			
William	L	-	2
			

Backset:

2-1/4" (57mm)	D	standard	
---------------	---	----------	--

Door Thickness:

8-14mm	0	standard	
--------	---	----------	--

Strike:

Glass Door Lock Strike (for use with wood, metal, and aluminum frames)	G	standard	1
Double Door Glass Door Strike (for use with glass door to glass frame/wall)	H	\$562.51	1

Handing:

Left Hand	L	-	
Left Hand Reverse	P	-	
Right Hand	R	-	
Right Hand Reverse	V	-	

Glass Door Lock Product Ordering Notes

Reverse models (LHR/RHR) are only compatible for GLASS frames

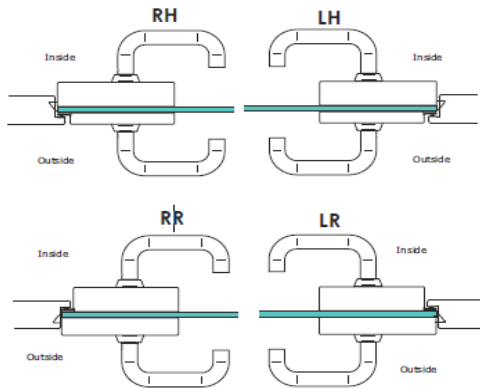

HS4 Wall Readers - ANSI

Wall readers can be used as either online or offline access update points and mounts to a single gang box

Description	Part No.	2022 List	Stock No.	Box Qty.
<u>Proximity BLE Mifare/DESfire Wall Reader</u>				
White	WRDB0A4W0	\$684.60	195318	1
Black	WRDB0A4B0	\$684.60	195319	1
<u>Proximity BLE Mifare/DESfire Wall Reader with Keypad</u>				
White	WRDB0A4WK	\$1,004.67	147200	1
Black	WRDB0A4BK	\$1,004.67	147201	1

HS4 Wall Readers - Euro

Wall readers can be used as either online or offline access update points

Description	Part No.	2022 List	Stock No.	Box Qty.
<u>Proximity BLE Mifare/DESfire Wall Reader</u>				
White	WRDB0E4W0	\$684.60	197088	1
Black	WRDB0E4B0	\$684.60	197089	1
<u>Proximity BLE Mifare/DESfire Wall Reader with Keypad</u>				
White	WRDB0E4WK	\$1,004.67	197090	1
Black	WRDB0E4BK	\$1,004.67	197093	1

HS4 Wall Readers - Mullion Mounted Readers

Small footprint wall readers can be used as either online or offline access update points

Description	Part No.	2022 List	Stock No.	Box Qty.
<u>Proximity BLE Mifare/DESfire Wall Reader</u>				
White	WRDB0M4W0	\$684.60	85158	1
Black	WRDB0M4B0	\$684.60	85159	1
<u>Panel Reader Mifare/DESfire</u>				
PCB	WRDB0P400	\$684.60	84466	1

HS4 Control Units

Control units connect the wall readers to the Software to provide updates

Description	Part No.	2022 List	Stock No.	Box Qty.
<u>Ethernet Controller with Housing</u>				
<i>controls 2 readers and up to 4 auxiliary controllers</i>				
with translucent housing	CU42E0TUS	\$1,945.10	195396	1
with gray housing	CU42E0GUS	\$1,945.10	195394	1
without housing	CU42E0US0	\$1,945.10	145966	1
<u>Auxiliary Controller with Housing</u>				
<i>controls 2 readers</i>				
with translucent housing	CU4200TUS	\$972.01	195399	1
with gray housing	CU4200GUS	\$972.01	195397	1
<u>Expansion Unit with Housing</u>				
<i>8 relay outputs and 4 inputs to control additional access control locking products such as a strike</i>				
with translucent housing	CU4EB8TUS	\$839.99	195413	1
with gray housing	CU4EB8GUS	\$839.99	195412	1

continued on next page

Optional Features

Description	Part No.	2022 List	Stock No.	Box Qty.
RJ45 Port <i>used when connecting Wall Reader to CU42xx via RJ45 cable for Reader 1 and Reader 2</i>	SP2248610	\$78.66	195409	1
RJ45 Port <i>used when connecting Wall Reader to CU42xx via RJ45 cable for one wall reader</i>	SP2248950	\$79.45	195410	1

HS4 Long Range Reader

Typically used in applications such as parking structures

Description	Part No.	2022 List	Stock No.	Box Qty.
Long Distance Reader				
Black	WRLUD24BUS	\$6,761.70	197300	1
Wiegand Signal Converter				
	WRLUDSIC1	\$774.55	197301	1
WRLUD Wall Reader Components				
4 Pin Connector for WRLUD Wall Reader	WRLUD4PC0	\$243.00	197302	1
Mounting Base for WRLUD Wall Reader	WRLUDMB40	\$1,035.07	197303	1
Screw Kit for WRLUD Wall Reader	WRLUDMBK1	\$25.12	197304	1
USB to RE485 Converter	WRLUDSNG3	\$1,171.74	197305	1
24V Power Supply for WRLUDSNG3 Converter	WRLUSPS24	\$835.91	197306	1
POC-UHF Field Detector for WRLUD Wall Reader	WRLUDPOC08	\$747.66	197336	1
Set of 4 Test Transponders for WRLUD Wall Reader	WRLUD4TT08	\$753.51	197337	1
UHF Long Distance Reader 10 meters cable (33 ft.)	WRLUDC100	\$361.02	198365	1
WRLUD Credentials				
Combination Cards - DESfire/UHF for WRLUD Wall Readers (Blank), 8k	PCD08KUH8	\$63.12	197340	1
Combination Cards - Mifare/UHF for WRLUD Wall Readers (Blank), 4k	PCM04KUH8	\$52.57	197344	1
Windshield Transponder ISO-Format UHF for WRLUD Wall Reader	PWU008B	\$35.05	197350	1
Metal Transponder ISO-Format UHF for WRLUD Wall Reader	PMU008B	\$98.17	197351	1
Long Range Reader Kit	2-679-0807	\$9,200.40	198392	
WRLUD24BUS - long range reader (black)				1
WRLUDSIC1 - Wiegand signal converter				1
WRLUD4PC0 - 4-pin connector for WRLUD wall reader				1
WRLUDMB40 - mounting base for WRLUD wall reader				1
WRLUDMBK1 - screw kit for WRLUD wall reader				1
WRLUDC10 - UHF long distance reader 10 meter cable (33 ft.)				1
Long Range Reader Frequency Conversion Kit	2-679-0808	\$2,007.65	198395	
WRLUDSNG3 - USB to RE485 Converter				1
WRLUSPS24 - 24V power supply for WRLUDSNG3 converter				1

HS4 RFnet Gateways & Nodes

Gateways and Nodes connects the HS4 locks to the wireless (802.15) network

Description	Part No.	2022 List	Stock No.	Box Qty.
RFnet Gateway				
<i>controls an additional 6 nodes plus the integrated node that controls 16 doors</i>				
<i>PoE capable</i>				
White	GATEWAYW2CUS	\$943.94	195310	1
Black	GATEWAYB2CUS	\$943.94	195311	1
RFnet Nodes				
White	RFNODE000	\$180.51	195313	1
RF Tester				
Wireless Test Kit	RFTESTERW01	\$735.98	195317	1
<i>measures the RF signal between two devices</i>				
<i>includes tester and DUT device</i>				

HS4 BLUEnet Gateways & Nodes

Gateways and Nodes connects the HS4 locks to the Bluetooth (BLE) network

Description	Part No.	2022 List	Stock No.	Box Qty.
Gateway				
<i>controls an additional 6 nodes plus the integrated node that controls 16 doors</i>				
<i>PoE capable</i>				
White	GATEWAYW3CUS	\$943.94	97497	1
Black	GATEWAYB3CUS	\$943.94	97495	1
Nodes				
White	RFNODE300	\$180.51	96070	1
Repeater				
White	REPEATER3US	\$180.51		1

HS4 Management Tools

Management tools are necessary on all projects to deploy and maintain proper credentials

Description	Part No.	2022 List	Stock No.	Box Qty.
<hr/>				
Portable Programming Device				
<i>PPDs are used to initialize locks and open them as needed</i>				
USB connection to PC	PPD800000	\$1,103.97	195470	1
PPD Replacement Cable	SPA001050	\$44.40	199580	1
<hr/>				
Proximity Card NCoder Mifare/DESfire BLE				
USB & Ethernet connection to PC	ECB04B0US	\$1,190.91	31629	1
DHCP Addressing				
Desktop Reader Capabilities				

ProAccess SPACE Software

HS4 software is a one-time charge with free updates (when released)

Description	Part No.	2022 List	Stock No.	Box Qty.
ProAccess SPACE - Basic				
4,000,000 users, 65,000 doors, no expiration period, no licensing fees locker, online monitoring, event engine, AMOK	SPABASIC0	\$896.71	195473	1
ProAccess SPACE - Online				
4,000,000 users, 65,000 doors, no expiration period, no licensing fees Basic + lockdown, antipassback, event stream, automatic key assignment, roll call, limited occupancy	SPAONLINE	\$1,673.71	195475	1
ProAccess SPACE - ID System				
4,000,000 users, 65,000 doors, no expiration period, no licensing fees Online + visitor management, badging module	SPAIDSYS0	\$3,452.82	195494	1
ProAccess SPACE - Partitional				
4,000,000 users, 65,000 doors, no expiration period, no licensing fees ID System + partitions	SPAPART00	\$4,039.15	195495	1
ProAccess SPACE - Demonstration				
10 users, 10 doors, no expiration period, no licensing fees all features	SPADEMO00	\$414.58	195497	1
ProAccess SPACE - Trial				
4,000,000 users, 65,000 doors, 90-day expiration period, no licensing fees all features	SPATRIAL0	no charge	195498	1
Upgrade from SPATRIAL0 to SPABASIC0	2-679-1016	\$896.71	49374	
Upgrade from SPATRIAL0 to SPAONLINE	2-679-1017	\$1,673.71	49375	
Upgrade from SPATRIAL0 to SPAIDSYS0	2-679-1018	\$3,452.82	49371	
Upgrade from SPATRIAL0 to SPAPART00	2-679-1019	\$4,039.15	49372	

ProAccess SPACE Software Upgrades

HS4 software can be upgraded at anytime or add modules as needed

			Upgrade to			
			SPAONLINE	SPAIDSYS0	SPAPART00	
Existing Software	SPABASIC	\$896.71	2-679-0890	2-679-0891	2-679-0892	
		\$777.00		\$2,556.11	\$3,142.43	
	SPAONLINE	\$1,673.71		2-679-0893	2-679-0894	
				\$1,779.11		\$2,365.44
	SPAIDSYS0	\$3,452.82			2-679-0895	
					\$586.33	
	SPAPART00	\$4,039.15				

continued on next page

ProAccess SPACE Software Modules

HS4 software can be upgraded at anytime or add modules as needed

Description	Part No.	2022 List	Stock No.	Box Qty.
ProAccess SPACE - Platform Modules				
RFnet Comms <i>enable the communication between system and RFnet locks and cylinders</i> <i>price per system, one time fee</i>	SPACE-OPT-0021	\$112.30	197414	1
BLUEnet Comms <i>enable the communication between system and BLE locks and cylinders</i> <i>price per door, one time fee</i>	SPACE-OPT-0033	\$142.14	97487	1
ProAccess SPACE - Add-On Modules				
Database Synchronization <i>establishes the link between databases to integrate different applications into different databases</i>	SPACE-OPT-0017	no charge	197330	1
Event Alarms & Communication Module <i>enables event alarms and sends emails to the operators when events are triggered</i>	SPACE-OPT-0032	\$1,177.43	197152	1
Matrix Locations & Functions <i>simplifies and streamlines the link between users and doors, making access planning simple and straightforward</i>	SPACE-OPT-0015	\$170.37	197328	1
ProAccess SPACE - Graphical Mapping				
Interface	GMI4SPACE	\$2,100.13	199213	1
Graphical Mapping	SPACE-OPT-0019	\$286.06	197332	1
Graphical Mapping Kit (includes GMI4SPACE & SPACE-OPT-0019)	2-679-0962	\$2,386.19	64045	
ProAccess SPACE - Mobile User Modules				
BLE Annual License Fee (<i>per system</i>)	SPACE-OPT-0028-2	\$879.52	64831	1
BLE Annual Fee (<i>per registered mobile phone number</i>) <i>Rates start in year 2 and are billed annually thereafter (subscription begins when software is activated)</i> <i>Users that are added during the billing period will be pro-rated</i> <i>BLE requires Ethernet Encoder (EC90ENUS0)</i>	SPACE-OPT-0016-1	\$5.92	197329	1
ProAccess SPACE - Salto Host Interface Protocol (SHIP)				
Alarm event engine for CCTV, fire alarm, etc. Feature is not included with a software package	SPACE-OPT-0018	\$1,130.05	197331	1
ProAccess SPACE - Hotel Module				
<i>enables ProAccess SPACE to work with rooms, guests, suites, group check-in, re-rooming through RF and extended stay through RF.</i>	SPACE-OPT-0022	no charge	197333	1
ProAccess SPACE - Elevator Protocol				
<i>enables ProAccess SPACE elevator communication module, allowing the software to manage third party systems such as Schindler PORT protocol.</i>	SPACE-OPT-0035	\$1,178.00		1

HS4 Smart Cards

Smart cards are available in 1K or 4K (4K is recommended for multi-application and/or more than 20 transactions per day)

Description	Part No.	2022 List	Stock No.	Box Qty.
1K Mifare				
Blank	PCM01KB-50	\$415.17	195559	50
4K Mifare				
Blank	PCM04KB-50	\$595.63	195561	50
Hager powered by Salto - 4K	PCM04KHA0001-50	\$554.91	139362	50
4K DESfire				
Blank	PCD04KB-50	\$595.63	195563	50
Hager powered by Salto - 4K	PCD04KHA0001-50	\$554.91		50
<i>When using NFC to encode cards, DESfire must be ordered</i>				
Ultralight C				
Blank	PCMULCB00	\$2.50	98764	1
Dual Technology				
Blank (4K Mifare and magnetic stripe)	PCM04KBH-50	\$603.45	195616	50
Pre-Marked				
Horizontal - 4K	PCM04KB-PM-50	\$603.45	195564	50
Construction Card				
Salto branded with Construction Card logo - 1K	PCM01KC00	\$35.05	195617	1
4K Contactless Mifare Smart Sticker (30mm diameter)				
White	PSM04K-20	\$240.11	195644	20

HS4 Smart Mifare Silicone Wristbands

Available in 1K and 4K (4K is recommended for multi-application and/or more than 20 transactions per day)

Description	Part No.	2022 List	Stock No.	Box Qty.
<ul style="list-style-type: none"> • waterproof • medium - 44mm inside diameter • large - 50mm inside diameter 				
4K Medium				
Blue	WBM04KBM-5	\$143.70	TBD	5
White	WBM04KWM-5	\$143.70	TBD	5
Green	WBM04KGM-5	\$143.70	TBD	5
Yellow	WBM04KYM-5	\$143.70	TBD	5
Red	WBM04KRM-5	\$143.70	TBD	5
Pink	WBM04KPM-5	\$143.70	TBD	5
Black (1K only)	WBM01KNM-5	\$143.70	TBD	5

continued on next page

1K Large

Blue	WBM01KBL-5	\$143.70	61452	5
White	WBM01KWL-5	\$143.70	TBD	5
Green	WBM01KGL-5	\$143.70	TBD	5
Yellow	WBM01KYL-5	\$143.70	TBD	5
Red	WBM01KRL-5	\$143.70	66517	5
Pink	WBM01KPL-5	\$143.70	TBD	5
Black	WBM01KNL-5	\$143.70	66517	5

4K Large

White	WBM04KWL-5	\$143.70	TBD	5
-------	------------	----------	-----	---

HS4 Smart Mifare Key FOBs*Available only in 4K*

Description	Part No.	2022 List	Stock No.	Box Qty.
-------------	----------	-----------	-----------	----------

- waterproof
- middle is quarter-sized

**Colored Frame with White Center**

Blue	PFM04KB-10	\$127.94	195632	10
Red	PFM04KR-10	\$127.94	195633	10
Green	PFM04KG-10	\$127.94	195635	10
Yellow	PFM04KY-10	\$127.94	195636	10
Black	PFM04KN-10	\$127.94	195637	10

HS4 Smart Mifare Bracelets*Available only in 1K*

Description	Part No.	2022 List	Stock No.	Box Qty.
-------------	----------	-----------	-----------	----------

- waterproof
- adjustable

**Adjustable**

Black	PBM01KN-10	\$127.94	195645	10
Red	PBM01KR-10	\$127.94	195646	10
Green	PBM01KG-10	\$127.94	195647	10
Blue	PBM01KB-10	\$127.94	195648	10

HS4 Demo Blocks

Lightweight demonstration blocks that showcase specific HS4 locking hardware or component.

Description	Part No.	2022 List	Stock No.	Box Qty.
Demo Blocks (blank - does not include Marketing skin or hardware)				
Wide Body Mortise Lock Prep	SP225460-AN	\$112.74	61461	1
Wide Body & Mini Cylindrical Lock Prep	SP225460-CA	\$112.74	61458	1
AElement Fusion Lock Prep	SP2255460-AFAN	\$112.74	TBD	1
Peripheral (i.e. reader and control unit)	SP225460-PE	\$112.74	61459	1
Marketing Skin - Hardware Specific (front skin)				
Wide Body	TBD			1
Mini	TBD			1
AElement Fusion	TBD			1
Readers	TBD			
Marketing Skin - Vertical Market (back skin)				
Assisted Living(mortise)	TBD			1
Assisted Living (cylindrical)	TBD			1
Commercial (mortise)	TBD			1
Commercial (cylindrical)	TBD			1
Education (mortise)	TBD			1
Education (cylindrical)	TBD			1
Multi-Family (mortise)	TBD			1
Multi-Family (cylindrical)	TBD			1

Power Supplies

HS4 power supply enclosures are designed specifically for HS4 control units, power supply modules and components.

How to Order Guide

29T HS4 Power Supplies	4 Four Openings	00 (default)	BLK Black	000000 (default)	C 12/24VDC Field Selectable
	X Ten Openings				

Description	Part No.	2022 List	Stock No.	Box Qty.
-------------	----------	-----------	-----------	----------

Power Supply Enclosure Configuration

4-Door Enclosure

29T4

\$1,456.44

Accommodates two HS4 Controllers (CU42E0, CU4200, CU4EB) *Sold Separately*

Enclosure Includes:

2-679-0994

- 6A access control power supply sub-assembly

- converts 120VAC, 60Hz input into a single 12VDC or 24VDC output

2-679-0999

- converts a 24VDC input into a regulated 5VDC or 12VDC selectable output at up to 6A supply current

2-679-1000

- designed to steer the power from either two (2) low voltage AC or DC power sources

2-679-0997

- Designed to be powered by one common power source which will provide power for both the board operation and locking devices, or two (2) totally independent power sources, one (1) providing power for board operation and the other for lock / accessory power

continued on next page

10-Door Enclosure

29TX

\$2,727.38

Accommodates five HS4 Controllers (CU42E0, CU4200, CU4EB) *Sold Separately**Enclosure Includes:***2-679-0995**

- 6A access control power supply sub-assembly
- converts 120VAC, 60Hz input into a single 12VDC or 24VDC output

2-679-0996

- 10A access control power supply sub-assembly
- converts 120VAC, 60Hz input into a single 12VDC output

2-679-1000

- designed to steer the power from either two (2) low voltage AC or DC power sources

2-679-0998

- Designed to be powered by one common power source which will provide power for both the board operation and locking devices, or two (2) totally independent power sources, one (1) providing power for board operation and the other for lock / accessory power

Finishes:

Black	00BLK	-
-------	-------	---

Voltage:

12/24 VDC Field Selectable	000000C	-
----------------------------	---------	---

Optional Battery Backup

Description	Part No.	2022 List	Stock No.	Box Qty.
7 Amp Hour Battery Backup 12VDC battery for security, access, surveillance and fire applications	2-679-1001	\$68.69	54313	1
12 Amp Hour Battery Backup 12VDC battery for security, access, surveillance and fire applications	2-679-1002	\$154.55	54310	1

Components

Description	Part No.	2022 List	Stock No.	Box Qty.
12VDC/24VDC Power Supply & Charger 6A power supply (12VDC or 24VDC output)	2-679-0994	\$914.94	54353	
12VDC/24VDC Power Supply & Charger 10A power supply (12VDC output)	2-679-0995	\$785.04	54349	
12VDC/24VDC Power Supply & Charger 10A power supply (24VDC output)	2-679-0996	\$740.25	54345	
Access Power Controller, 4 Fused Relay Outputs, FAI, Board Converts one (1) 12 to 24 VAC or VDC input into four (4) independently controlled fuse protected outputs	2-679-0997	\$168.17	54346	
Access Power Controller, 8 Fused Relay Outputs, FAI, Board Converts one (1) 12 to 24 VAC or VDC input into eight (8) independently controlled fuse protected outputs	2-679-0998	\$227.11	54332	

continued on next page

Voltage Regulator

Converts a 24VDC input into a regulated 5VDC or 12VDC selectable output (6A) 2-679-0999 \$190.01 54327

Power Distribution Module, 8 Fused Outputs

Designed to steer the power from either two (2) low voltage AC or DC power sources 2-679-1000 \$127.78 54319

Dual Input Fused Access Power Controller

Designed to steer the power from two (2) independent low voltage 12 or 24 VDC power sources into eight (8) independently controlled fuse protected outputs 2-679-1005 \$357.06 54311

PSU Network Communication Module

Compatible with 2-679-0994, 2-679-0995, 2-679-0994 2-679-1006 \$342.86 54306 1

Enables power supply status monitoring and control of two (2) power supply/chargers over a LAN/WAN or USB connection

PSU Network Power Distribution Module

Retrofits with most currently installed multi-output power supply/chargers 2-679-1007 \$547.65 54307 1

Facilitates monitoring, reporting and control of one (1) or two (2) low voltage AC or supervised DC power supply/chargers over the network

Platform	SAN	SVN	RFnet	BLUEnet	KS
Description	Stand Alone Network where the PPD transfers data between the lock and database.	Salto Virtual Network is a true data on card system where the user credentials are updated at online locks and those updates are passed on to the offline locks by the credential.	Wireless communication using the ZigBee (IEEE 802.15) energy management protocol and allows real-time control, monitoring and reporting. Provides real-time control for Wide Body, AElement, and GEO locks.	Bluetooth communication (4.1) using allows real-time control, monitoring and reporting. Provides real-time control for Mini, AElement, Fusion and NEO locks. Allows users to use their smartphones as their credential.	Cloud based access control system designed to give the administrator control from their smartphone, tablet, or PC and without system network requirements.
Most Commonly Used	where the end user budget is the greatest concern	where controlled access and audit trails are desired	when real-time control of openings such as lockdown and monitoring of these openings.		when the system admin wants to provide remote access to a user
examples	<i>churches that have too many brass keys in circulation</i>	<i>multi-family and assisted living facilities that want to grant differing access rights and capture event history</i>	<i>education facilities, some areas of healthcare facilities, and high security facilities</i>		<i>commonly found in retail and rental properties</i>

Locking Hardware					Environment
Wide Body	●	●		●	Indoor & Outdoor
Mini	●	●		●	Indoor Only
AElement	●	●	●	●	Indoor Only
Fusion	●	●		●	Indoor Only
GEO	●	●	●		Indoor Only
NEO	●	●		●	Indoor & Outdoor
Exit Trim	●	●		●	Indoor & Outdoor
Glass Door Lock	●	●	●	●	Indoor Only
Locker Lock	●	●		●	Indoor Only

Local Network (Server) - Required Components

Wall Reader		●			
Control Unit		●			
Gateways			●	●	
Nodes			●	●	
PPD	●	●	●	●	
NCoder	●	●	●	●	

Local Network (Server) Software Modules

SPACE-OPT-0021			●		
SPACE-OPT-0033				●	

Cloud - Required Components

Wall Reader					●
Control Unit					●
IQ Hub					●
Voucher					●

Credentials

Card	●	●	●	●	●
Wristband	●	●	●	●	
Key FOB	●	●	●	●	●
Mobile (iOS & Android)				●	●

Infrastructure Design

Users		4 Million		Unlimited
Openings		65,000		Unlimited
Nodes per Gateway & Readers per Control Unit	One primary CU and four auxiliary CU per IP. Each CU controls 2 readers.	One Gateway and six nodes per IP. Each controls 16 openings (112 openings per IP)	BLUEnet - same as RFnet SVN+Flex - 2 flex locks per node and a total of 10 flex locks per gateway	

