

VON DUPRIN®

Quiet Electric Latch Retraction-QEL

Featuring 98/99, 94/95
and 33A/35A series
exit devices

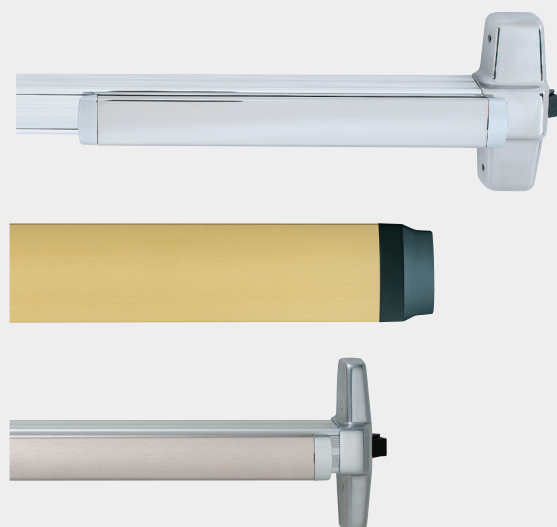

Overview

Quiet electric latch retraction (QEL) provides electronic control of an exit device for environments where limited operational noise is desired. The QEL option is Von Duprin's solution of choice for hospitals, libraries, museums and theaters where ambient noise can be disruptive. It is available on all Von Duprin 98/99, 94/95 and 33A/35A series exit devices.

These devices always provide mechanical egress. The electrified latch retraction can also be activated by an access system or building automation system to unlatch the exit device momentarily. Often the QEL is used with a credential reader and access control system to unlock the door momentarily for authorized users.

The QEL can also be configured to electronically retract the latch for an extended period of time to allow free entry. This is a convenient alternative to mechanical dogging. If manual dogging is required, the hex dogging option is available, to order specify HD-QEL. Special center case dogging is also available for 98/99 rim and vertical systems, specify SD-QEL.

The QEL option is available on panic devices and fire rated devices. Fire rated openings have several additional requirements. They must be self latching and self closing. To satisfy these requirements the QEL must be paired with an automatic operator and under the control of an automatic fire alarm system when used on fire rated openings.

Features and benefits

- QEL option available on all 98/99, 94/95 and 33A/35A series exit devices
- Energy efficient motorized latch retraction utilizes standard 2 amp power supply, enabling longer wire runs from power source
- Quiet operation in both mechanical and electronic states
- Modular design allows for a simplified installation
- On-board installation and troubleshooting diagnostics built into device
- Auto adjust latch retraction – automatically adjusts latch throw and pull
- Pushbar is pulled in electronically for quieter operation when dogged
- Vandal resistant – detects and responds to events of attack and tampering

Specifications compliance

- Devices are BHMA Certified to ANSI/BHMA A156.3 (2001) Grade 1 for Exit Devices
- Devices are UL and cUL Listed as "Panic Hardware" (UL 305) and as "Fire Exit Hardware" (UL 10C)
- The QEL Conversion Kit is UL Classified under "Accessories for Single-Point Locks and Latches and Fire Exit Hardware" (UL 10C)

Electronic specifications

QEL electrical load

Voltage	24 VDC
Current	1.0 A Inrush (0.5 sec) 0.14 A Holding

QEL wire run lengths

Distance (one way)	Wire gauge
200'	18 AWG
320'	16 AWG
500'	14 AWG
800'	12 AWG

Accessories

The QEL has a low inrush current = 1.0 amps, so it can be used with standard Schlage power supplies. When powering multiple components, verify that the amperage requirements of all components combined does not exceed the power supply output rating, see table below for output ratings.

Schlage PS902	Schlage PS904	Schlage PS906
up to 2 amps	up to 4 amps	up to 6 amps

The QEL device is compatible with the following equipment: PS900 Series power supplies - PS902, 904, 906, 914; 900 Series Option Boards - 900-2RS, 900-4R, 900-4RL, 900-2Q; PS873 Power Supply including 871-2, 871-2Q, 873-4TD/AO Option Boards. The power transfer is also sold separately. Please refer to Von Duprin catalog for more information on EPT-2/EPT-10 power transfers and PS900 series power supplies.

How to order

- Standard** – Use prefix QEL, example QEL99L.
- Special Center Case Dogging** – Use prefix SD-QEL, example SD-QEL99L.
- Hex Dogging** – Use prefix HD-QEL, example HD-QEL99L.

Popular application

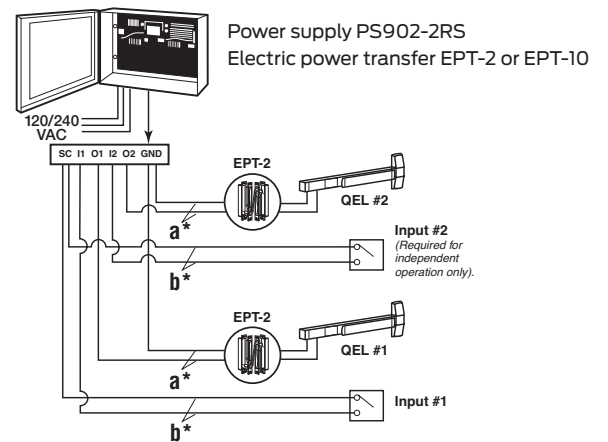

About Allegion

Allegion (NYSE: ALLE) is a global pioneer in safety and security, with leading brands like CISA®, Interflex®, LCN®, Schlage®, SimonsVoss® and Von Duprin®. Focusing on security around the door and adjacent areas, Allegion produces a range of solutions for homes, businesses, schools and other institutions. Allegion is a \$2 billion company, with products sold in almost 130 countries. For more, visit www.allegion.com.

KRYPTONITE ■ LCN ■  ■ STEELCRAFT ■ VON DUPRIN



© 2019 Allegion
006586, Rev.12/19
www.allegion.com/us